



PX2210MW
LCD Monitor

USER'S GUIDE

www.planar.com

The information contained in this document is subject to change without notice. This document contains proprietary information that is protected by copyright. All rights are reserved. No part of this document may be reproduced, translated to another language or stored in a retrieval system, or transmitted by any means, electronic, mechanical, photocopying, recording, or otherwise, without prior written permission. Windows is a registered trademark of Microsoft Inc. Other brand or product names are trademarks of their respective holders.

TABLE OF CONTENTS

For your safety-----	5
Safety precautions -----	6
Special notes on lcd monitors -----	7
Before you operate the monitor -----	7
Features -----	7
Packing list -----	7
Installation instructions -----	8
Controls and connectors -----	9
Adjusting the viewing angle-----	10
Operating instructions -----	11
General instructions -----	11
Front panel control -----	12
How to adjust a setting -----	13
Adjusting the picture -----	14-17
Plug and play -----	18
Technical support (FAQ) -----	19
Error message & possible solution -----	20
Appendix -----	21
Specifications -----	21
Factory preset timing table -----	22
Connector pin assignment -----	23-24
Product registration and technical support -----	25

FOR YOUR SAFETY

Before operating the monitor, please read this manual thoroughly. This manual should be retained for future reference.

FCC Class B Radio Frequency Interference Statement

WARNING: (FOR FCC CERTIFIED MODELS)

NOTE: This equipment has been tested and found to comply with the limits for a Class B digital device, pursuant to Part 15 of the FCC Rules. These limits are designed to provide reasonable protection against harmful interference in a residential installation. This equipment generates, uses and can radiate radio frequency energy, and if not installed and used in accordance with the instructions, may cause harmful interference to radio communications. However, there is no guarantee that interference will not occur in a particular installation. If this equipment does cause harmful interference to radio or television reception, which can be determined by turning the equipment off and on, the user is encouraged to try to correct the interference by one or more of the following measures:

1. Reorient or relocate the receiving antenna.
2. Increase the separation between the equipment and receiver.
3. Connect the equipment into an outlet on a circuit different from that to which the receiver is connected.
4. Consult the dealer or an experienced radio/TV technician for help.

NOTICE:

1. The changes or modifications not expressly approved by the party responsible for compliance could void the user's authority to operate the equipment.
2. Shielded interface cables and AC power cord, if any, must be used in order to comply with the emission limits.
3. The manufacturer is not responsible for any radio or TV interference caused by unauthorized modification to this equipment. It is the responsibilities of the user to correct such interference.

WARNING:

To prevent fire or shock hazard, do not expose the monitor to rain or moisture. Dangerously high voltages are present inside the monitor. Do not open the cabinet. Refer servicing to qualified personnel only.

PRECAUTIONS

- Do not use the monitor near water, e.g. near a bathtub, washbowl, kitchen sink, laundry tub, swimming pool or in a wet basement.
- Do not place the monitor on an unstable cart, stand, or table. If the monitor falls, it can injure a person and cause serious damage to the appliance. Use only a cart or stand recommended by the manufacturer or sold with the monitor. If you mount the monitor on a wall or shelf, use a mounting kit approved by the manufacturer and follow the kit instructions.
- Slots and openings in the back and bottom of the cabinet are provided for ventilation. To ensure reliable operation of the monitor and to protect it from overheating, be sure these openings are not blocked or covered. Do not place the monitor on a bed, sofa, rug, or similar surface. Do not place the monitor near or over a radiator or heat register. Do not place the monitor in a bookcase or cabinet unless proper ventilation is provided.
- The monitor should be operated only from the type of power source indicated on the label. If you are not sure of the type of power supplied to your home, consult your dealer or local power company.
- The monitor is equipped with a three-pronged grounded plug, a plug with a third (grounding) pin. This plug will fit only into a grounded power outlet as a safety feature. If your outlet does not accommodate the three-wire plug, have an electrician install the correct outlet, or use an adapter to ground the appliance safely. Do not defeat the safety purpose of the grounded plug.
- Unplug the unit during a lightening storm or when it will not be used for long period of time. This will protect the monitor from damage due to power surges.
- Do not overload power strips and extension cords. Overloading can result in fire or electric shock.
- Never push any object into the slot on the monitor cabinet. It could short circuit parts causing a fire or electric shock. Never spill liquids on the monitor.
- Do not attempt to service the monitor by yourself; opening or removing covers can expose you to dangerous voltages and other hazards. Please refer all servicing to qualified service personnel.
- To ensure satisfactory operation, use the monitor only with UL listed computers which have appropriate configured receptacles marked between 100 - 240V AC, Min. 5A.
- The wall socket shall be installed near the equipment and shall be easily accessible.

Important Recycle Instruction:



Lamp(s) inside this product contain mercury and must be recycled or disposed of according to local, state or federal laws. For more information, contact the electronic industries alliance at WWW.EIAE.ORG. For lamp specific disposal information check WWW.LAMPRECYCLE.ORG.

SPECIAL NOTES ON LCD MONITORS

The following symptoms are normal with LCD monitor and do not indicate a problem.

NOTES

- Due to the nature of the fluorescent light, the screen may flicker during initial use. Turn off the Power Switch and then turn it on again to make sure the flicker disappears.
- You may find slightly uneven brightness on the screen depending on the desktop pattern you use.
- The LCD screen has effective pixels of 99.99% or more. It may include blemishes of 0.01% or less such as a missing pixel or a pixel lit all of the time.
- Due to the nature of the LCD screen, an afterimage of the previous screen may remain after switching the image when the same image has been displayed for a long time. The monitor will slowly recover from this.
- When the screen becomes black or flashing, or cannot illuminate any more, contact your dealer or service center to replace parts. Don't repair the screen by yourself!

BEFORE YOU OPERATE THE MONITOR

FEATURES

- 21.5"(549mm) TFT Color LCD monitor
- 16:9 Widescreen
- Crisp, Clear Display for Windows
- Recommended Resolutions: *1920X 1080@60Hz*
- Ergonomic Design
- Space Saving, Compact Case Design

CHECKING THE CONTENTS OF THE PACKAGE

The product package should include the following items:

1. LCD monitor
2. Base
3. User's Guide
4. Power Cord
5. D-sub Cable
6. DVI Cable
7. Audio Cable

INSTALLATION INSTRUCTIONS

BASE

The monitor is supplied complete with a stand. If you prefer to wall mount the monitor, please follow the instructions below to remove the stand. Be sure to include the stand with the monitor if it is necessary to return the unit.

CAUTION

- Put the monitor on a stable surface. The monitor may cause injury or damage if it falls or is dropped.
- Do not give a strong impact to the monitor. It may cause damage.
- Unplug the monitor before removal or installation to avoid electric shock or damage.

<Installation>

- ① Put a piece of soft cloth on the table beforehand to prevent the monitor from being scratched. Lay the monitor flat on a table with front face down.
- ② Insert stand into the monitor as shown in figure.
- ③ Install the stand-base to the stand.

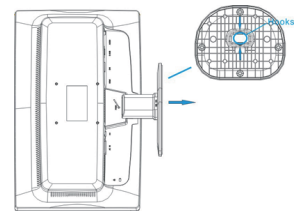
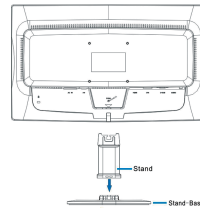
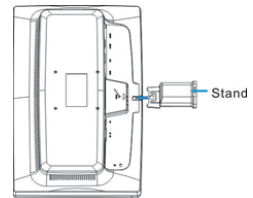

<Remove>

- ① Put a piece of soft cloth on the table beforehand to prevent the monitor from being scratched. Lay the monitor flat on a table with front face down.
- ② Press and hold the hooks inside, and pull the stand-base.
- ③ Insert thin stick into hole, pull the stand while push the stick.

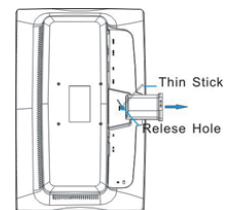

CONTROLS AND CONNECTORS

SIGNAL CABLE

Connecting the Signal Cable: Plug one end of the signal cable to the LCD monitor and the other end to a computer or a video source.

Connecting the Power Cord: Plug the AC-power cord one end to LCD monitor's AC input socket , the other end to Wall outlet.

Connecting the Audio Cable: Connect the audio cable between the monitor's audio input and the PC's audio output.

Caution: *If the AC outlet is not grounded (with three holes), install the proper grounding adapter (not supplied).*

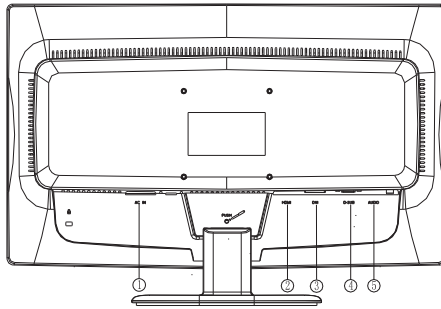

Figure 2 Connecting Cables

1.	Power Cable
2.	HDMI Cable
3.	DVI Cable
4.	D-SUB Cable
5.	Audio Cable

ADJUSTING THE VIEWING ANGLE

- For optimal viewing it is recommended to look at the full face of the monitor, then adjust the monitor's angle to your own preference.
- Hold the stand so you do not topple the monitor when you change the monitor's angle.
- You are able to adjust the monitor's angle from -5° to 19° .

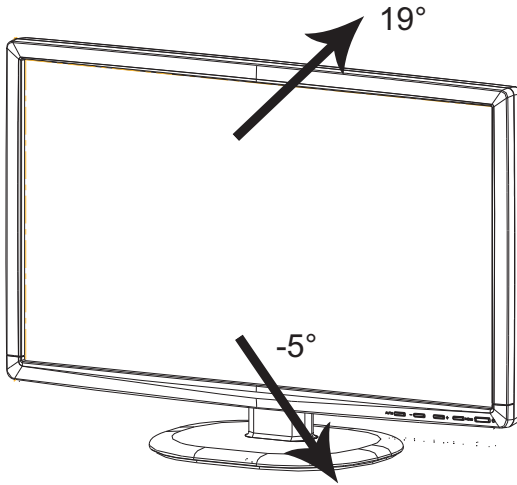

Figure 3

NOTES

- Do not touch the LCD screen when you change the angle. It may cause damage or break the LCD screen.
- Careful attention is required not to catch your fingers or hands when you change the angle.

OPERATING INSTRUCTIONS

GENERAL INSTRUCTIONS

Press the power button to turn the monitor on or off. The other control buttons are located at front panel of the monitor (See Figure 4). By changing these settings, the picture can be adjusted to your personal preferences.

- The power cord should be connected.
- Connect the video cable from the monitor to the video card.
- Press the power button to turn on the monitor position. The power indicator will light up.

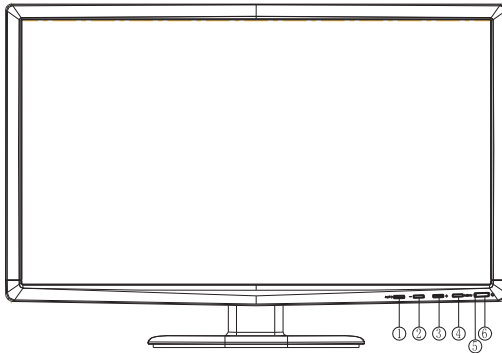

Figure 4 External Control Button

EXTERNAL CONTROLS

1.	Source/AutoAdjust/EXIT button
2.	ECO (-)
3.	Volume Hotkey(+)
4.	Menu / Enter
5.	Power Indicator
6.	Power button

FRONT PANEL CONTROL

- **Power Button:**
Press this button to switch ON/OFF monitor's power.
- **Power Indicator :**
Blue --- Power On mode.
Orange --- Power saving mode.
- **MENU/ENTER:**
Activates OSD menu or function adjust confirm .
- **ECO/(-)**
Activates the ECO control when the OSD is OFF or navigate through adjustment icons when OSD is ON or adjust a function when function is activated.
- **Volume/+:**
Activates the volume control when the OSD is OFF or navigate through adjustment icons when OSD is ON or adjust a function when function is activated.
- **Source/Auto Adjust/Exit:**
When the OSD is OFF, pressing Auto/Source button will toggle between sources. Press continuously to select the input source indicated in the message bar.Press Menu/Enter button to change to the selected source.
Auto configure hot key:(VGA input only) When the OSD is OFF,press and hold down the button for 2 seconds to auto configure.
when OSD menu is ON, this button will act as a Exit Key (Exit OSD menu)

OSD Lock Function: To lock the OSD, press and hold the MENU button while the monitor is off and then press power button to turn the monitor on. To un-lock the OSD - press and hold the MENU button while the monitor is off and then press power button to turn the monitor on.

NOTES

- Do not install the monitor in a location near heat sources such as radiators or air ducts, or in a place subject to direct sunlight, or excessive dust or mechanical vibration or shock.
- Save the original shipping carton and packing materials, as they will come in handy if you ever have to ship your monitor.
- For maximum protection, repackage your monitor as it was originally packed at the factory.
- To keep the monitor looking new, periodically clean it with a soft cloth. Stubborn stains may be removed with a cloth lightly dampened with a mild detergent solution. Never use strong solvents such as thinner, benzene, or abrasive cleaners, since these will damage the cabinet. As a safety precaution, always unplug the monitor before cleaning it.
- do not scratch the screen with hard things, It may cause permanent damage.
- Don't leak liquid into monitor which will result in the damage of component



HOW TO ADJUST A SETTING



1. Press the MENU-button to activate the OSD window.
2. Press + or - to navigate through the functions. Once the desired function is highlighted, press the MENU-button to activate it. If the function selected has a sub-menu, press + or - again to navigate through the sub-menu functions. Once the desired function is highlighted, press MENU-button to activate it.
3. Press + or - to change the settings of the selected function.
4. To exit and save, select the exit function. If you want to adjust any other function, repeat steps 2-3.





Figure 5 The OSD Message

ADJUSTING THE PICTURE

Main Menu Item	Main Menu Icon	Sub Menu	Description
Luminance		Contrast	Adjusts image brightness in relation to the background.
		Brightness	Adjusts overall image brightness.
		ECO mode	Choose one of the following ECO mode settings: Standard: Brightness=90, Contrast=50 (adjustable) Text: Brightness=20, Contrast=80 (nonadjustable) Internet: Brightness=40, Contrast=80 (nonadjustable) Game: Brightness=60, Contrast=80 (nonadjustable) Sports: Brightness=100, Contrast=80 (nonadjustable) Movie: Brightness=80, Contrast=80 (nonadjustable)
		Gamma	Gamma Adjustment
		DCR	Enhances Contrast Ratio Note: When this function is turned "On" you cannot adjust the current settings for Contrast, Brightness, ECO mode or Gamma.
Image Setup		Clock (VGA input only)	Adjust picture Clock to reduce Vertical-Line noise.
		Focus (VGA input only)	Adjust Picture Phase to reduce Horizontal-Line noise.
		H.Position (VGA input only)	Adjust the horizontal position of the picture.
		V. Position (VGA input only)	Adjust the vertical position of the picture.

Main Menu Item	Main Menu Icon	Sub Menu	Description
Color Temp.		Normal	Normal Color Temperature (RGB value is nonadjustable)
		Warm	Warm Color Temperature (RGB value is nonadjustable)
		Cool	Cool Color Temperature (RGB value is nonadjustable)
		sRGB	sRGB Color Temperature (RGB value is nonadjustable)
		User	Adjust R.G.B.Y.C.M levels as desired. User - R: Adjust Red Gain. User- G: Adjust Green Gain. User- B: Adjust Blue Gain. User- Y: Adjust Red/Green (Yellow) Gain. User- C: Adjust Green/Blue (Cyan) Gain. User- M : Adjust Red/Blue (Magenta) Gain. Note: When Color Temp. is set to "User" Color Temp., DCR, Color Boost, Picture Boost can be adjusted. When Color Temp is set to "Normal," Color Temp., DCR, Color Boost, Picture Boost are reset to factory presets.
Color Boost		Full Enhance	Full Enhance
		Nature Skin	Red level is raised
		Green Field	Green level is raised
		Sky-Blue	Blue level is raised
		Auto Detect	Auto gain for input signal
		Demo	Demonstrates Color Boost Enhancement in half of screen. In this mode when Nature Skin, Green Field, Sky Blue, or Auto Detect are activated, the enhanced boost will appear on the left side of the screen.

Main Menu Item	Main Menu Icon	Sub Menu	Description
Picture Boost		Frame Size (When Bright Frame is on)	Adjust the size of the Frame.
		Brightness (When Bright Frame is on)	Brightness Adjustment for Enhance Area
		Contrast (When Bright Frame is on)	Contrast Adjustment for Enhance Area
		Hue (When Bright Frame is on)	Hue Adjustment for Enhance Area
		Saturation (When Bright Frame is on)	Saturation Adjustment for Enhance Area
		Position (When Bright Frame is on)	Adjust the horizontal position of the Frame Adjust the vertical position of the Frame
		Bright Frame	Enhance Area function Note: Bright Frame and Frame size settings are not stored.
OSD Setup		H. Position	Adjust the horizontal position of the OSD.
		V. Position	Adjust the vertical position of the OSD.
		Timeout	Adjust the OSD timeout.
		Language	Set OSD display language. (English is default setting)

Main Menu Item	Main Menu Icon	Sub Menu	Description
Extra		Input Select	Select input source (VGA, DVI, or HDMI).
		Auto Adjust	Auto Adjust the H/V Position, Focus and Clock of picture. VGA Input Only
		DDC/CI	Turns on or off the two-way communication between the graphics card and the monitor With DDC/CI turned on, some monitor settings can be adjusted through the graphics card using a computer
		Reset	Reset OSD settings.
		Aspect	Set aspect ratio.
		Information	Show the resolution, H/V Frequency, and input port of current input signal.

PLUG AND PLAY

Plug & Play DDC 2B Feature

This monitor is equipped with VESA DDC 2B capabilities according to the VESA DDC STANDARD. It allows the monitor to inform the host system of its identity and, depending on the level of DDC used, communicate additional information about its display capabilities.

The DDC 2B is a bidirectional data channel based on the I²C protocol. The host can request EDID information over the DDC 2B channel.

THIS MONITOR WILL APPEAR TO BE NON-FUNCTIONAL IF THERE IS NO VIDEO INPUT SIGNAL. IN ORDER FOR THIS MONITOR TO OPERATE PROPERLY, THERE MUST BE A VIDEO INPUT SIGNAL.

This monitor meets the Green monitor standards as set by the Video Electronics Standards Association (VESA) and The Swedish Confederation Employees (NUTEK). This feature is designed to conserve electrical energy by reducing power consumption when there is no video-input signal present. When there is no video input signal this monitor, following a time-out period, will automatically switch to an OFF mode. This reduces the monitor's internal power supply consumption. After the video input signal is restored, full power is restored and the display is automatically redrawn. The appearance is similar to a "Screen Saver" feature except the display is completely off. The display is restored by pressing a key on the keyboard, or clicking the mouse.

TECHNICAL SUPPORT (FAQ)

Problem & Question	Possible Solution
Power LED is not on	*Check if the Power Switch is in the ON position *Power Cord should be connected
No Plug & Play	*Check if the PC system is Plug & Play compatible *Check if the Video Card is Plug & Play compatible *Check if the D-15 plug pin of Video Cable is bent
Picture is fuzzy	*Adjust the Contrast and Brightness Controls.
Picture bounces or a wave pattern is present in the picture	*Move electrical devices that may cause electrical interference.
The power LED is ON but there's no video or no picture.	*Computer Power Switch should be in the ON position. *Computer Video Card should be snugly seated in its slot. *Make sure monitor's video cable is properly connected to the computer. *Inspect monitor's video cable and make sure none of the pins are bent. *Make sure computer is operational by hitting the CAPS LOCK key on the keyboard while observing the CAPS LOCK LED. The LED should either turn ON or OFF after hitting the CAPS LOCK key.
Missing one of the primary colors (RED, GREEN, or BLUE)	*Inspect the monitor's video cable and make sure that none of the pins are bent.
Screen image is not centered or sized properly.	*Adjust pixel frequency (CLOCK) and FOCUS or press hot-key (AUTO).
Picture has color defects (white does not look white)	*Adjust RGB color or select color temperature.
Horizontal or vertical disturbances on the screen	*Use win 95/98 shut-down mode Adjust CLOCK and FOCUS or perform hot- key (AUTO-key).

CLOCK (pixel frequency) controls the number of pixels scanned by one horizontal sweep. If the frequency is not correct, the screen shows vertical stripes and the picture has not correct width.

FOCUS adjusts the phase of the pixel clock signal. With a wrong phase adjustment the picture has horizontal disturbances in light picture.

For FOCUS and CLOCK adjustment use "dot-pattern" or win 95/98 shut-down mode pattern.

ERROR MESSAGE & POSSIBLE SOLUTION

NO SIGNAL :

1. Check that the signal-cable is properly connected , If the connector is loose, tighten the connector's screws.
2. Check the signal-cable's connection pins for damage.

INPUT NOT SUPPORT :

Your computer has been set to unsuitable display mode ,set the computer to display mode given in the following table.

APPENDIX

SPECIFICATIONS

LCD Panel	Driving system	TFT 21.5"Color LCD
	Viewable Image Size	546mm diagonal
	Pixel pitch	0.248 (H) × 0.248 (V)
Input	Video	R, G, B Analog Interface DVI HDMI
	Separate Sync.	H/V TTL
	H-Frequency	Analog:24-80kHz,Digital:30kHz-83kHz
	V-Frequency	Analog&Digital:56-76Hz
Dot Clock		170MHz
Max. Resolution		1920x1080@60Hz
Plug & Play		VESA DDC2B™
Power Consumption	ON Mode	≤43W(TYP)
	OFF Mode	≤1W
Input Connector		D-Sub mini 15 pin, DVI-D 24 pin, HDMI
Input Video Signal		Analog:0.7Vp-p(Standard)75Ω, Positive Digital:DVI(Digital Visual Interface Standard Rev.1.0) compliance Digital:HDMI(1.3)
Power Source		100~240VAC,50/60Hz
Environmental Considerations		Operating Temp: 5° to 40°C Storage Temp.: -20° to 60°C Operating Humidity: 15% to 90%
Dimension		512.7(W)X366.0(H)X181.5(D)
Weight (N. W.)		4.3kg ± 0.2kg
Power Consumption (Maximum)		52Watts
Regulatory Compliance		UL/cUL, CE, FCC B

FACTORY PRESET TIMING TABLE

STANDARD	RESOLUTION	HORIZONTAL FREQUENCY(KHZ)	VERTICAL FREQUENCY(Hz)
VGA	640 x 480	31.469	59.94
	640 x 480	35	66.667
	640 x 480	37.861	72.809
Mac VGA	640 x 480	37.5	75
Dos-mode	720 x 400	31.469	70.087
SVGA	800 x 600	35.156	56.25
	800 x 600	37.879	60.317
	800 x 600	48.077	72.188
	800 x 600	46.875	75
Mac SVGA	832 x 624	49.726	74.551
XGA	1024 x 768	48.363	60.004
	1024 x 768	56.476	70.069
	1024 x 768	57.5	72.074
	1024 x 768	60.023	75.029
SXGA	1280 x 1024	67.981	60.02
	1280 x 1024	79.976	75.025
WXGA+	1440 x 900	55.935	59.887
	1440 x 900	70.635	74.984
WSXGA+	1680 x 1050	65.29	59.954
HDTV	1920 X1080	66.295	59.887

CONNECTOR PIN ASSIGNMENT

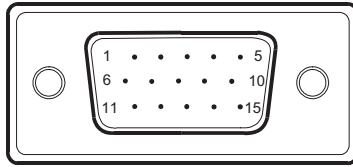

15 - Pin Color Display Signal Cable

PIN NO.	DESCRIPTION	PIN NO.	DESCRIPTION
1.	Red	9.	+5V
2.	Green	10.	Detect Cable
3.	Blue	11.	Ground
4.	Ground	12.	DDC-Serial Data
5.	Ground	13.	H-Sync
6.	R-Ground	14.	V-Sync
7.	G-Ground	15.	DDC-Serial Clock
8.	B-Ground		

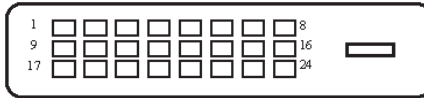

24 - Pin Color Display Signal Cable

PIN NO.	DESCRIPTION	PIN NO.	DESCRIPTION
1.	TMDS Data 2-	13.	TMDS Data 3+
2.	TMDS Data 2+	14.	+5V Power
3.	TMDS Data 2/4 Shield	15.	Ground(for+5V)
4.	TMDS Data 4-	16.	Hot Plug Detect
5.	TMDS Data 4+	17.	TMDS Data 0-
6.	DDC Clock	18.	TMDS Data 0+
7.	DDC Data	19.	TMDS Data 0/5 Shield
8.	N.C.	20.	TMDS Data 5-
9.	TMDS Data 1-	21.	TMDS Data 5+
10.	TMDS Data 1+	22.	TMDS Clock Shield
11.	TMDS Data 1/3 Shield	23.	TMDS Clock +
12.	TMDS Data 3-	24.	TMDS Clock -

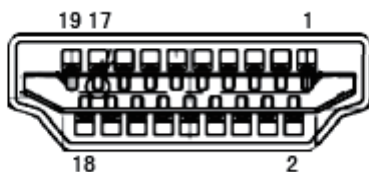

Pin No.	Signal Name	Pin No.	Signal Name	Pin No.	Signal Name
1	TMDS Data 2+	9	TMDS Data 0	17	DDC/CEC Ground
2	TMDS Data 2 Shield	10	TMDS Clock +	18	+5V Power
3	TMDS Data 2	11	TMDS Clock Shield	19	Hot Plug Detect
4	TMDS Data 1+	12	TMDS Clock		
5	TMDS Data 1 Shield	13	CEC		
6	TMDS Data 1	14	Reserved (N.C. on device)		
7	TMDS Data 0+	15	SCL		
8	TMDS Data 0 Shield	16	SDA		

Product Registration and Technical Support

Register Your Planar Products Today

Thank you choosing Planar. To assure you receive all the benefits of your Planar product and services, register your Planar product today.

Visit our website to register your product at

http://www.planar.com/support/product_registration.html

Cables, Replacement Lamps, Accessories

To find cables, replacement lamps and accessories for your Planar projector, LCD monitor, touch screen or other Planar products visit our online store at

www.PlanarOnline.com or find other stores who carry Planar products at

<http://www.planar.com/howtobuy>

Technical Support

Visit Planar at <http://www.planar.com/support> for product registration, operations manuals, touch screen drivers, warranty information and access to Planar's Technical Library for online troubleshooting.

To speak with Planar Customer Support please have you model and serial number available and dial:

Planar Support

Tel: 1-866-PLANAR1 (866-752-6271) or +1 503-748-5799 outside the US. Hours: 24 hours a day, 7 days a week.

Toll or long distance charges may apply.

Planar Systems, Inc.

Customer Service

24x7 Online Technical Support: <http://www.planar.com/support>

1195 NW Compton Drive

Beaverton, OR 97006-1992

Tel: 1-866-PLANAR1 (866-752-6271), or +1 503-748-5799 outside the United States,

Hours: 24 hours a day, 7 days a week

©2009 Planar Systems, Inc.

Planar is a registered trademark of Planar Systems, Inc. Other brands and names are the property of their respective owners. Technical information in this document is subject to change without notice.

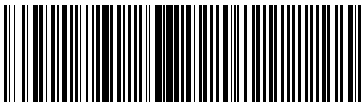

Q41G2201935 2C